

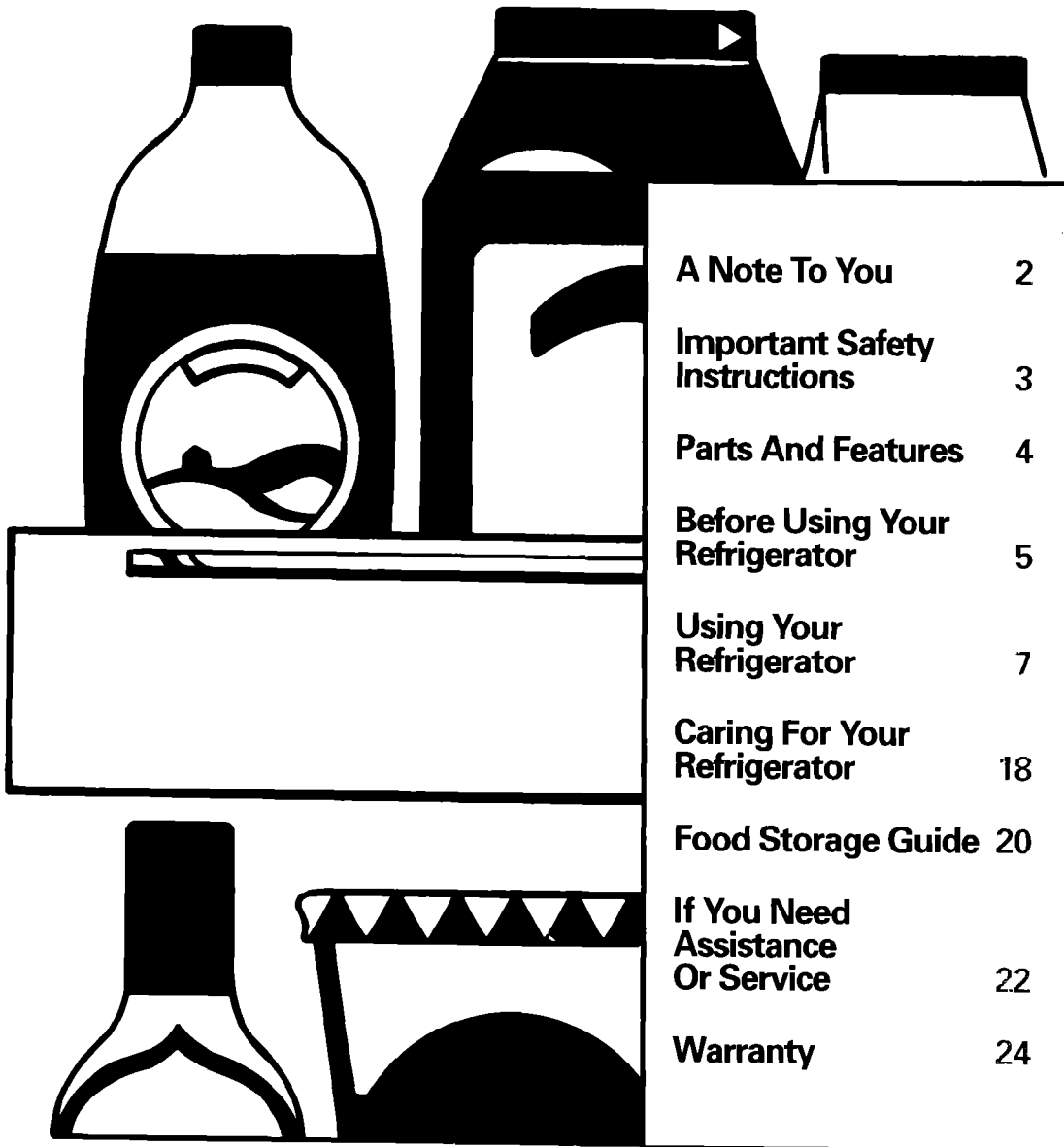

Use And Care

G U I D E



A Note To You	2
Important Safety Instructions	3
Parts And Features	4
Before Using Your Refrigerator	5
Using Your Refrigerator	7
Caring For Your Refrigerator	18
Food Storage Guide	20
If You Need Assistance Or Service	22
Warranty	24

NO-FROST REFRIGERATOR-FREEZERS
WITH THIRSTCRUSHER™

5/93

A MODELS 3ED27DQ 3ED25DQ 3ED22DQ
6ED27DQ 6ED25DQ 6ED22DQ

A Note To You

Thank you for buying a Whirlpool appliance.

You have purchased a quality, *world-class* home appliance. Years of engineering experience have gone into its manufacturing. To ensure that you will enjoy many years of trouble-free operation, we have developed this Use and Care Guide. It is full of valuable information on how to operate and maintain your appliance properly and safely. Please read it carefully. Also, please complete and mail the Ownership Registration Card provided with your appliance. This will help us notify you about any new information on your appliance.

Your safety is important to us.

This guide contains safety symbols and statements. Please pay special attention to these symbols and follow any instructions given. Here is a brief explanation of the use of each symbol.

WARNING

This symbol will help alert you to such dangers as personal injury, burns, fire and electrical shock.

CAUTION

This symbol will help you avoid actions which could cause product damage (scratches, dents, etc.) and damage to your personal property.

Help when you need it.

If you ever have a question concerning your appliance's operation, or if you need service, first see "If You Need Assistance Or Service" on page 22. If you need further help, feel free to call an authorized Whirlpool* service company. When calling, you will need to know your appliance's complete model number and serial number. You can find this information on the model and serial number label (see diagram on page 4). For your convenience, we have included a handy place below for you to record these numbers, the purchase date from the sales slip and your dealer's name and telephone number. Keep this book and the sales slip together in a safe place for future reference.

Model Number _____

Dealer Name _____

Serial Number _____

Dealer Phone _____

Purchase Date _____

Important Safety Instructions

⚠ WARNING

To reduce the risk of fire, electrical shock, or injury when using your refrigerator, follow these basic precautions:

- Read all instructions before using the refrigerator.
- Child entrapment and suffocation are not problems of the past. Junked or abandoned refrigerators are still dangerous ... even if they will "just sit in the garage a few days." If you are getting rid of your old refrigerator, do it safely.
- Never allow children to operate, play with, or crawl inside the refrigerator.
- Never clean refrigerator parts with flammable fluids. The fumes can create a fire hazard or explosion.

• FOR YOUR SAFETY •

DO NOT STORE OR USE GASOLINE OR OTHER FLAMMABLE VAPORS AND LIQUIDS IN THE VICINITY OF THIS OR ANY OTHER APPLIANCE. THE FUMES CAN CREATE A FIRE HAZARD OR EXPLOSION.

– SAVE THESE INSTRUCTIONS –

Help us help you

Please:

- Install and level the refrigerator on a floor that will hold the weight and in an area suitable for its size and use.
- Do not install the refrigerator near an oven, radiator or other heat source.
- Do not use the refrigerator in an area where the room temperature will fall below 13°C (55°F).
- Keep the refrigerator out of the weather.
- Connect the refrigerator only to the proper kind of outlet, with the correct electrical supply and grounding.
- Do not load the refrigerator with food before it has time to get properly cold.
- Use the refrigerator only for the uses described in this manual.
- Properly maintain the refrigerator.
- Be sure the refrigerator is not used by anyone unable to operate it properly.

Also, remove tape and any inside labels (except the model and serial number label) before using the refrigerator.

To remove any remaining glue:

- Rub briskly with thumb to make a ball, then remove.
- OR
- Soak area with liquid hand dishwashing detergent before removing glue as described above. Do not use sharp instruments, rubbing alcohol, flammable fluids or abrasive cleaners. These can damage the material. See "Important Safety Instructions" above.

NOTE: Do not remove any permanent instruction labels inside your refrigerator. Do not remove the Tech Sheet fastened under the refrigerator at the front.

PARTS AND FEATURES

Parts And Features

This section contains captioned illustrations of your appliance. Use them to become familiar with where all parts and features are located and what they look like.

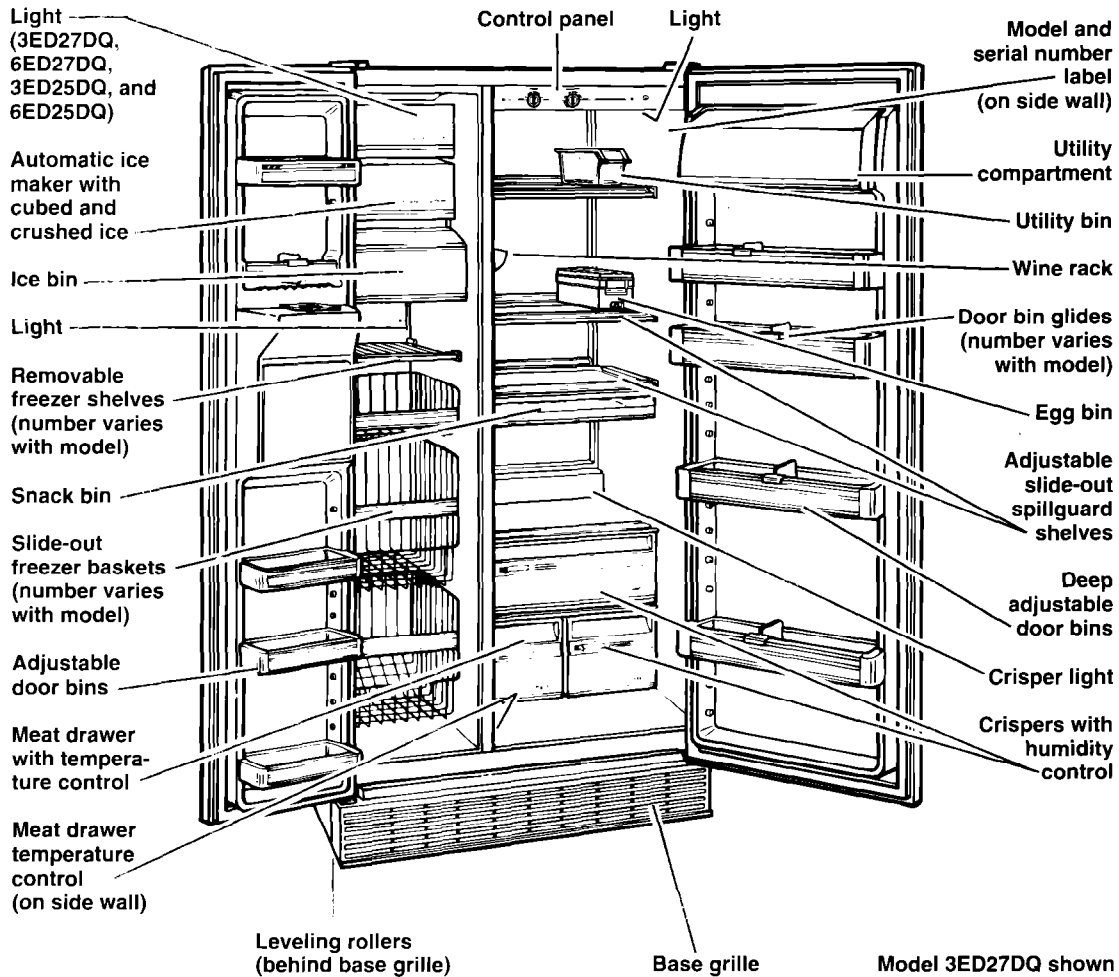

Control panel

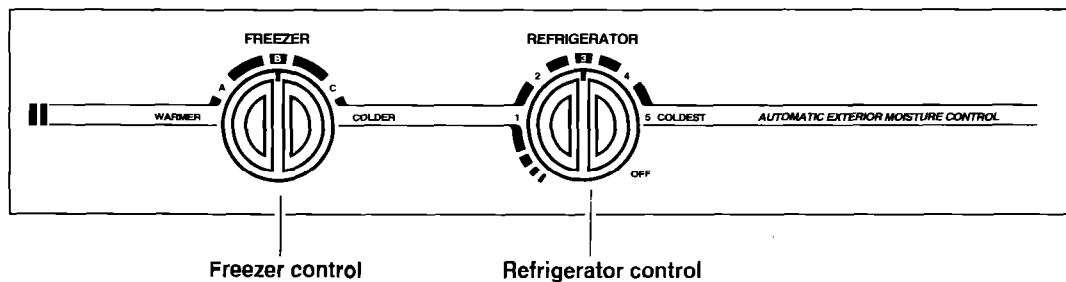

Before Using Your Refrigerator

In This Section		Page	Page
Cleaning it	5	Installing it properly	5
Plugging it in	5	Leveling it	6

It is important to prepare your refrigerator for use. This section will tell you how to clean it, connect it to a power source, install it and level it.

Cleaning it

Clean your refrigerator before using it, if necessary. See cleaning instructions on page 18.

Plugging it in

Recommended Grounding Method

A 220 or 240 Volt, 50 Hz., AC only 15 or 20 ampere fused and properly grounded electrical supply is required. It is recommended that a separate circuit serving only this appliance be provided. Use a receptacle which cannot be turned off with a switch or pull chain. Do not use an extension cord.

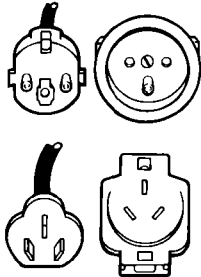

Installing it properly

1. Allow 1.25 cm (1/2 inch) space on each side and at the top of the refrigerator for ease of installation.
2. If the refrigerator is to be against a wall, you might want to leave extra space on the hinge side closest to the wall so the door can be opened wider.
For ED27DQ only: A minimum of 2.9 cm (1 1/8 inch) between the refrigerator door and wall is required, or a minimum of 3.8 cm (1 1/2 inch) between the freezer door and wall is required.
3. The refrigerator can be flush against the wall.
4. Make sure ice maker water supply has been connected. Refer to Installation Instructions.

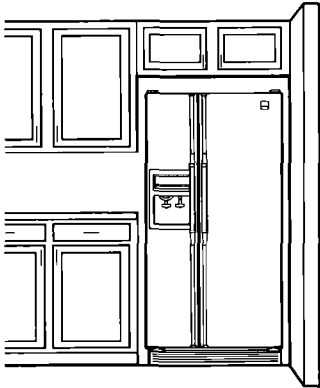

BEFORE USING YOUR REFRIGERATOR

Leveling it

Your refrigerator has 2 front leveling screws—one on the right and one on the left. To adjust one or both of these, follow the directions below.

1. Remove base grille. (See page 16.)
2. To raise front, turn screw clockwise.
3. To lower front, turn screw counterclockwise.
4. Check with level.
5. Replace base grille. (See page 16.)

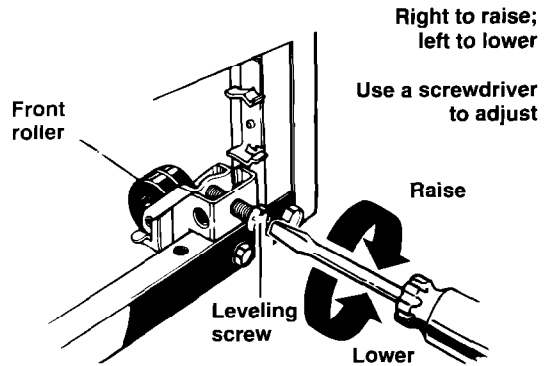

Using Your Refrigerator

In This Section		Page	Page
Setting the controls	7	Removing the freezer baskets	11
Changing the control settings	8	Removing the freezer shelf	11
Adjusting the refrigerator shelves	8	THIRSTCRUSHER* dispensing system	12
Adjusting the door bins	9	Using the automatic ice maker	13
Adjusting the door bin glides	9	Removing the ice maker storage bin	14
Removing the crisper and crisper cover	9	Solving common ice maker problems	15
Adjusting the crisper humidity control	10	Removing the door trim (dispenser area)....	15
Removing the meat drawer and cover	10	Removing the base grille	16
Adjusting the meat drawer temperature	10	Changing the light bulbs	16
Removing the snack bin	11	Understanding the sounds you may hear ...	17
Adjusting the wine rack	11	Saving energy	17

In order to obtain the best possible results from your refrigerator, it is important that you operate it properly. This section will tell you how to do just that.

Setting the controls

Controls for the refrigerator and freezer are in the refrigerator. When the refrigerator is plugged in for the first time:

1. **Set the Refrigerator Control to 3.**
Refrigerator Control adjustments range from 1 (warmest) to 5 (coldest).

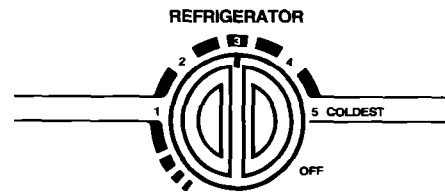

2. **Set the Freezer Control to B.**
Freezer Control adjustments range from A (warmest) to C (coldest).
3. Give the refrigerator time to cool down completely before adding food. This may take several hours.

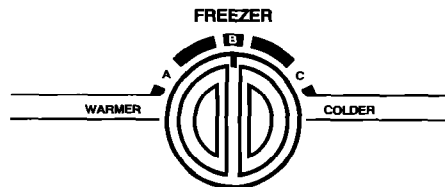

The settings indicated above should be correct for normal, household refrigerator usage. The controls will be set correctly when milk or juice is as cold as you like and when ice cream is firm. If you need to adjust these settings, see "Changing the control settings" on page 8.

NOTE: The Automatic Exterior Moisture control continuously guards against moisture build-up on the outside of your refrigerator cabinet. This control does not have to be set or adjusted.

Changing the control settings

If you need to adjust temperatures in refrigerator or freezer, use the settings listed in the chart below as a guide.

- Adjust the Refrigerator Control first.
- Wait at least 24 hours between adjustments.
- Then adjust the Freezer Control if needed.

CONDITION:	REASON:	RECOMMENDED CONTROL SETTINGS:	
If Refrigerator Section is TOO WARM	Door opened often Large amount of food added Room temperature too warm	Refrigerator Freezer	4 A
If Freezer Section is TOO WARM	Door opened often Large amount of food added Very cold room temperature (can't cycle often enough)	Refrigerator Freezer	3 C
If Refrigerator Section is TOO COLD	Controls not set correctly for your conditions	Refrigerator Freezer	2 B
If ICE isn't MADE FAST ENOUGH	Heavy ice usage Very cold room temperature (can't cycle often enough)	Refrigerator Freezer	3 C
If BOTH SECTIONS are TOO WARM	Door opened often Large amount of food added Very warm or very cold room temperatures	Refrigerator Freezer	4 B

Adjusting the refrigerator shelves

Shelves can be adjusted to match the way you use your refrigerator. Glass shelves are strong enough to hold bottles, milk and other heavy food items.

To remove glass shelves:

1. Remove items from shelf.
2. Slide shelf out with an even, constant pull.
3. Lift front and slide the rest of the way out.

To move shelf guides to a new position:

1. Lift front of guide. Pull guide forward off rear support. Repeat for other guide.
2. To replace guide, push guide onto rear support. Push front of guide down onto support.

To replace glass shelves:

1. Guide rear of shelf into shelf guide.
2. Slide shelf into place.

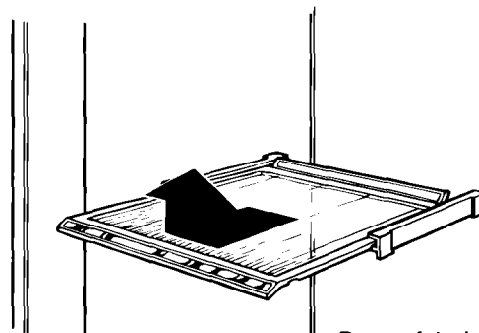

Be careful when handling glass items.

Adjusting the door bins

To remove door bins:

1. Lift bin up.
2. Pull bin straight out.

To replace door bins:

1. Slide bin in above desired support button.
2. Push bin down until it stops.

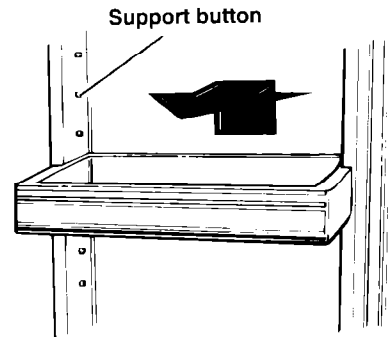

Adjusting the door bin glides

The door bin glides can be used to secure odd-shaped items or to separate other items.

1. Grasp glide.
2. Slide glide along bin.

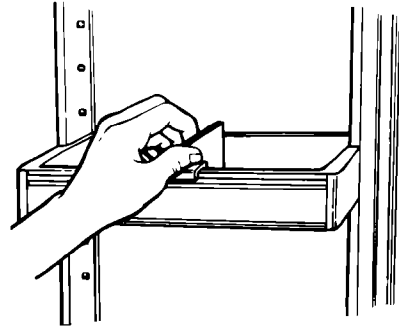

Removing the crisper and crisper cover

To remove the crisper:

1. Slide the crisper straight out to the stop.
2. Lift the front slightly.
3. Slide out the rest of the way.
4. Replace in reverse order.

To remove the cover:

1. Hold cover firmly with both hands and lift front of cover off supports.
2. Lift cover out by pulling up and out.

To replace the cover:

1. Fit back of cover into notch supports on walls of refrigerator.
2. Lower front into place.

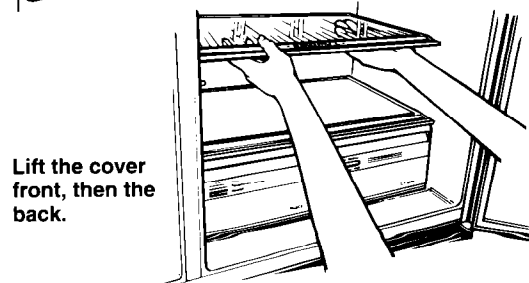
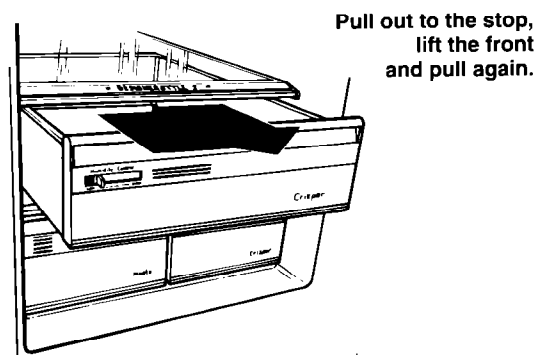

Adjusting the crisper humidity control

You can control the amount of humidity in the moisture-sealed crisper.

- The control can be adjusted to any setting between LOW and HIGH.
- LOW (open) lets moist air out of the crisper for best storage of fruits and vegetables with skins.
- HIGH (closed) keeps moist air in the crisper for best storage of fresh, leafy vegetables.

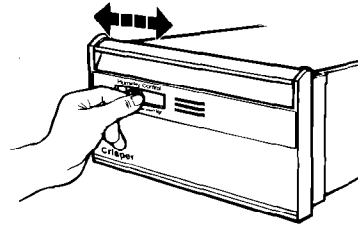

Removing the meat drawer and cover

To remove the meat drawer:

1. Slide the meat drawer straight out to the stop.
2. Lift the front slightly.
3. Slide out the rest of the way.
4. Replace in reverse order.

Pull out to the stop, lift the front and pull again.

To remove the cover:

1. Remove meat drawer and crisper.
2. Lift front of cover off supports.
3. Lift cover out by pulling up and out.

To replace the cover:

1. Fit back of cover into notch supports on walls of refrigerator.
2. Lower front into place.
3. Replace meat drawer and crisper.

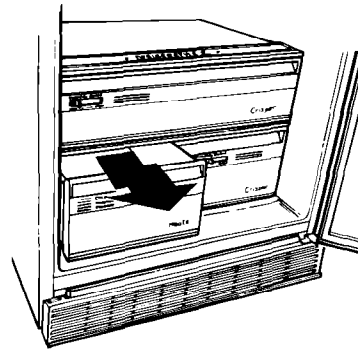

Adjusting the meat drawer temperature

Cold air flows against the meat drawer through an opening between the freezer and the refrigerator. This helps keep the meat drawer colder than the rest of the refrigerator for better storage of meats.

Slide the control to let more or less cold air through.

Use control to adjust meat drawer temperature.

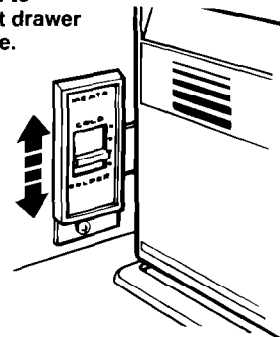

Removing the snack bin

To remove the snack bin:

1. Slide snack bin straight out to the stop with an even, constant motion.
2. Lift the front.
3. Slide bin out the rest of the way.
4. Replace in reverse order.

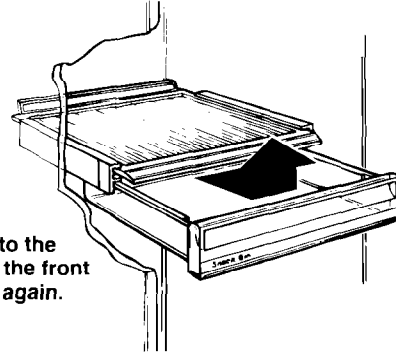

Adjusting the wine rack

To remove the wine rack:

1. Lift front of wine rack.
2. Pull rack off rear support.
3. Replace in reverse order.

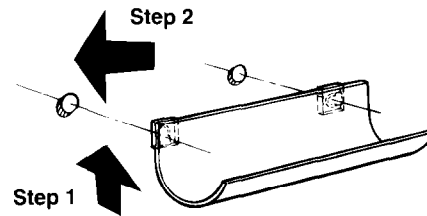

Removing the freezer baskets

To remove a basket:

1. Slide basket out to the stop.
2. Lift the front to clear the stop.
3. Slide basket out the rest of the way.

To replace a basket:

1. Place basket on the slides.
2. Make sure the wire stops clear the front of the slides.
3. Slide basket in all the way.

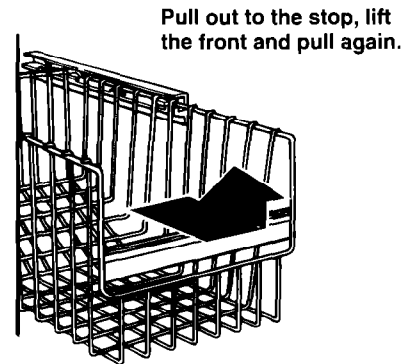

Removing the freezer shelf

To remove the shelf:

1. Lift right side of shelf off supports.
2. Slide shelf out of shelf support holes.
3. Replace in reverse order.

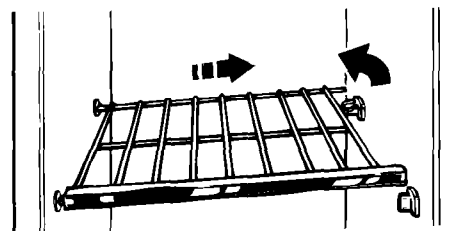

THIRSTCRUSHER* dispensing system

⚠ WARNING

Personal Injury Hazard

Tumbling ice and pressure on a fragile glass can break it. Do not use a fragile glass when dispensing ice or water.

Doing so could result in personal injury or breakage.

The ice dispenser

Ice is dispensed from the ice maker storage bin in the freezer. When the dispenser bar is pressed, a trapdoor opens in a chute between the dispenser and the ice bin. Ice is moved from the bin and falls through the chute. When the dispenser bar is released, a buzzing sound may be heard for a few seconds as the trapdoor closes. The dispenser system will not operate when the freezer door is open.

For crushed ice, cubes are crushed before being dispensed. This may cause a slight delay when dispensing crushed ice. Noise from the ice crusher is normal, and pieces of ice may vary in size.

When changing from CRUSHED to CUBE, a few ounces of crushed ice will be dispensed along with the first cubes.

To dispense ice:

1. For **cubed ice**, move Ice Selector Switch to CUBE position.

For **crushed ice**, move Ice Selector Switch to CRUSHED position.

2. Press a **sturdy** glass against the ice dispenser bar. Hold glass close to dispenser opening so ice does not fall outside of glass.
3. Remove the glass to stop dispensing.

NOTE: The first few batches of ice may have an off-flavor from new plumbing and parts. Throw the ice away. Also, large amounts of ice should be taken from the ice bin, not through the dispenser.

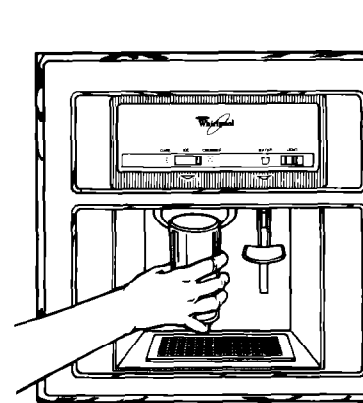
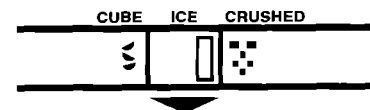
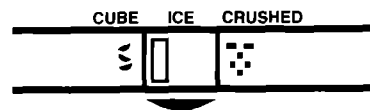

The water dispenser

Chilled water comes from a tank behind the meat drawer. It holds approximately 1.5 L (1½ quarts).

When the refrigerator is first hooked up, press the water dispenser bar with a glass or jar until you have drawn and discarded 1.9 or 2.8 L (2 or 3 quarts). The water you draw and discard will rinse the tank and pipes.

Allow several hours to chill a new tankful.

NOTE: The small tray beneath the dispenser is designed to evaporate **small** spills. There is no drain in this tray. **Do not** pour water into it.

To dispense water:

1. Press a **sturdy** glass against the water dispenser bar.
2. Remove the glass to stop dispensing.

NOTE: Dispense enough water every week to maintain a fresh supply.

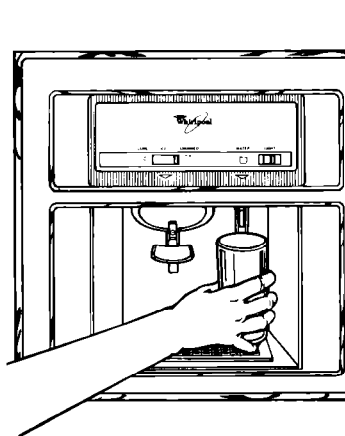

The dispenser light

To turn on **night light**, slide dispenser **LIGHT** switch to the left. See page 17 for directions for changing the dispenser light bulb.

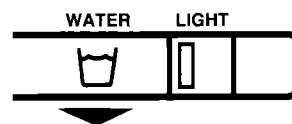

Using the automatic ice maker

Here are a few things you will want to know about your automatic ice maker:

- The ON/OFF lever is a wire signal arm.
 - Down ... to make ice automatically.
 - Up ... to shut off the ice maker.
- **NOTE: Do not turn ice maker on until it is connected to the water supply. Instructions for ice maker water supply hook up are attached to the back of the refrigerator cabinet.**
- It is normal for ice crescents to be attached by a corner. They will break apart easily.
- The ice maker will not operate until the freezer is cold enough to make ice. This can take overnight.
- If ice is not being made fast enough and more ice is needed, turn the Refrigerator Control toward a higher number. Wait a day and, if necessary, turn the Freezer Control toward C.
- Good water quality is important for good ice quality. It is not recommended that the ice maker be connected to a softened water supply. Water softener chemicals, such as salt from a malfunctioning softener, can damage the ice maker mold and lead to poor ice quality. If a softened water supply cannot be avoided, it is important that the water softener be well maintained and operating properly.

Raise signal arm to stop ice maker.

Lower signal arm to start ice maker.

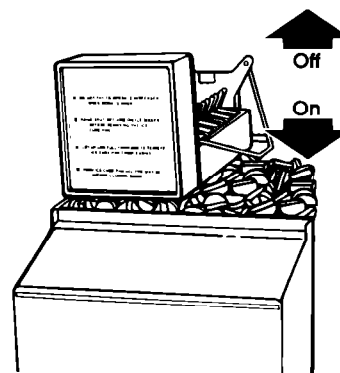

Removing the ice maker storage bin

Remove, empty and clean the storage bin if:

- the ice dispenser has not, or will not, be used for a week or more.
- a power failure causes ice in the bin to melt and freeze together.
- the ice dispenser is not used regularly.

To remove ice bin:

1. Pull the covering panel out from the bottom and slide it to the rear.
2. Lift the signal arm so it clicks into the OFF (up) position. Ice can still be dispensed, but no more can be made.
3. Lift the front of the storage bin and pull it out.
4. Empty the ice bin. Use hot or warm water to melt the ice if necessary. **Never use anything sharp** to break up ice in the bin. This can damage the bin and dispenser mechanism.
5. Wash with mild detergent. Rinse well. Do not use harsh or abrasive cleaners or solvents.
6. When replacing the bin, make sure it is pushed in all the way. Then push the signal arm down to the ON position to restart ice production.

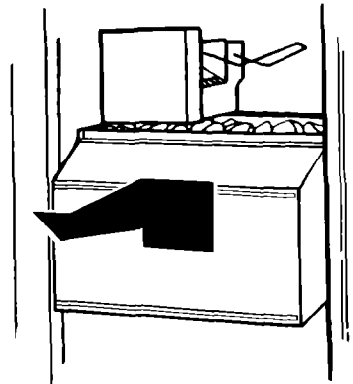
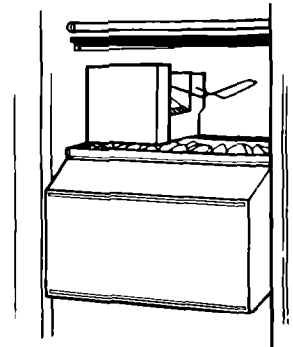

Solving common ice maker problems

PROBLEM	CAUSE	SOLUTIONS
Ice dispenser won't work	<ul style="list-style-type: none"> • Freezer door open • Ice bin not properly installed • Wrong ice in bin • Dispenser not used for extended periods, causing ice cubes to melt together 	<ul style="list-style-type: none"> • Close the freezer door. • Make sure bin is pushed in all the way. • Use only crescents from ice maker. Shake the bin occasionally to keep cubes separated and to obtain increased storage capacity. • Dump old ice and make a new supply.
Ice dispenser stops working	<ul style="list-style-type: none"> • Ice dispenser bar held in too long 	<ul style="list-style-type: none"> • Wait about 3 minutes for the dispenser motor to reset. • Large amounts of ice should be taken from the bin, not through the dispenser.
Off-taste or odor in ice	<ul style="list-style-type: none"> • Ice attracts airborne odors; old ice • Water quality • Foods not properly wrapped • Ice bin and freezer may need cleaning • Plumbing to ice maker • New ice maker 	<ul style="list-style-type: none"> • Dump old ice and make a new supply. Store excess ice in covered container. • Water containing minerals (such as sulfur) may require a filter to remove. • Wrap properly. See pages 20 and 21. • Clean freezer and ice bin. See cleaning chart on page 18. • Follow Installation Instructions for proper ice maker water supply hook up. (See back of refrigerator cabinet.) • The first few loads of ice from a new ice maker may have an off-taste. Dump ice and make a new supply.

Removing the door trim (dispenser area) (3ED27DQ and 6ED27DQ only)

To remove the trim:

1. Remove all items from the shelf.
2. Pull trim piece straight up at each end.

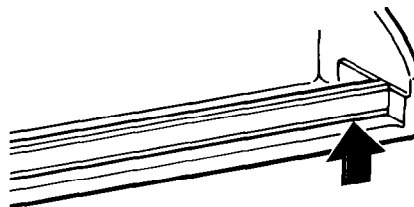

To replace the trim:

1. Locate each end of trim piece above the trim pocket opening in refrigerator door liner.
2. Push the trim piece straight down until it stops.
3. Replace items on the shelf.

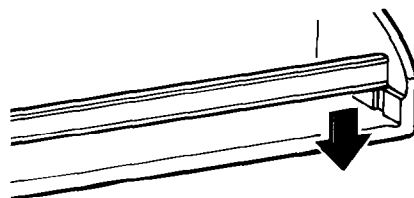

Removing the base grille

To remove the grille:

1. Open both doors.
2. Pull base grille forward to release the support tabs from the metal clips.
3. **Do not remove Tech Sheet** fastened behind the grille.

To replace the grille:

1. Line up grille support tabs with metal clips.
2. Push firmly to snap into place.
3. Close the doors.

See cleaning instructions for defrost pan and condenser coils on page 19.

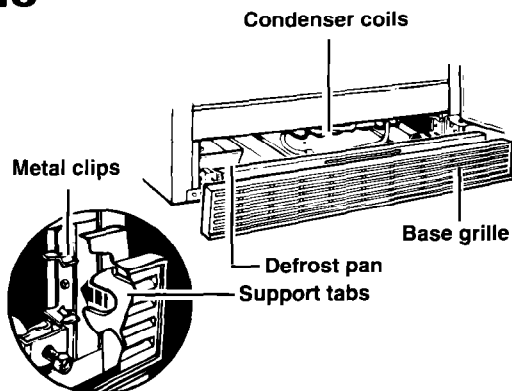

Changing the light bulbs

⚠ WARNING

Electrical Shock Hazard

Before removing a light bulb, either unplug the refrigerator or disconnect the electricity leading to it at the main power supply. Failure to do so could result in personal injury.

To change refrigerator light:

1. Disconnect refrigerator from power supply.
2. Reach behind the Control Console to remove bulb.
3. Replace bulb with a 40-watt appliance bulb.
4. Reconnect refrigerator to power supply.

To change crisper light:

1. Disconnect refrigerator from power supply.
2. Pull top of light shield forward until it snaps free.
3. Lower light shield to clear bottom supports.
4. Pull light shield straight out to remove.
5. Replace bulb with a 40-watt appliance bulb.
6. Replace light shield in reverse order.
7. Reconnect refrigerator to power supply.

To change light below ice bin:

1. Disconnect refrigerator from power supply.
2. Push in sides of light shield until it snaps free.
3. Replace bulb with a 40-watt appliance bulb.
4. Replace light shield.
5. Reconnect refrigerator to power supply.

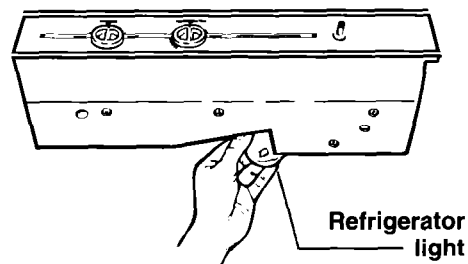

To change light behind quick freeze compartment (3ED27DQ, 6ED27DQ, 3ED25DQ and 6ED25DQ):

1. Disconnect refrigerator from power supply.
2. Lift and secure quick freeze compartment door.
3. Remove light shield by pulling top forward.
4. Replace bulb with a 40-watt appliance bulb.
5. Replace light shield.
6. Reconnect refrigerator to power supply.

To change dispenser area light:

1. Disconnect refrigerator from power supply.
2. Reach through dispenser area to remove bulb.
3. Replace with a heavy-duty 10-watt bulb, which can be purchased from your Whirlpool dealer.
4. Reconnect refrigerator to power supply.

NOTE: Not all commercial appliance bulbs will fit your refrigerator. Be sure to replace a bulb with one of the same size and shape.

Understanding the sounds you may hear

Your new refrigerator may make sounds that your old one didn't. Because the sounds are new to you, you might be concerned about them. Don't be. Most of the new sounds are normal. Hard surfaces like the floor, walls and cabinets can make the sounds seem louder.

The following describes the kinds of sounds that might be new to you, and what may be making them.

Slight hum, soft hiss

You may hear the refrigerator's fan motor and moving air.

Clicking or snapping sounds

The thermostat makes a definite click when the refrigerator stops running. It also makes a sound when the refrigerator starts. The defrost timer will click when the defrost cycle starts.

Water sounds

When the refrigerator stops running, you may hear gurgling in the tubing for a few minutes after it stops. You may also hear defrost water running into the defrost water pan.

Ice maker sounds

- trickling water
- thud (clatter of ice)

You may hear buzzing (from the water valve), trickling water and the clatter of ice dumped into the bin.

Running sounds

Your refrigerator has a high-efficiency compressor and motor. It will run longer than older designs. It may even seem to run most of the time.

Saving energy

You can help your refrigerator use less electricity.

- Check door gaskets for a tight seal. Level the cabinet to be sure of a good seal.
- Clean the condenser coils regularly.
- Open the door as few times as possible. Think about what you need before you open the door. Get everything out at one time. Keep food organized so you won't have to search for what you want. Close door as soon as food is removed.

- Go ahead and fill up the refrigerator, but don't overcrowd it so air movement is blocked.
- It is a waste of electricity to set the refrigerator and freezer to temperatures colder than they need to be. If ice cream is firm in the freezer and drinks are as cold as your family likes them, that's cold enough.
- Make sure your refrigerator is not next to a heat source such as a range, water heater, furnace, radiator or in direct sunlight.

Caring For Your Refrigerator

In This Section		Page	Page
Cleaning your refrigerator	18	Power interruptions	20
Holiday and moving care	19		

Your refrigerator is built to give you many years of dependable service. However, there are a few things you can do to help extend its product life. This section will tell you how to clean your refrigerator and what to do when going on holiday, moving or during a power outage.

Cleaning your refrigerator

Both the refrigerator and freezer sections defrost automatically. But both should be cleaned about once a month to help prevent odors from building up. Spills should be wiped up right away.

To clean your refrigerator, turn the Refrigerator Control to OFF, unplug it, take out all removable parts and clean the refrigerator according to the following directions.

⚠ WARNING

Personal Injury Hazard

Refrigeration system tubes are located near the defrost pan and can become hot. Remove and install defrost pan carefully. Failure to do so could result in personal injury.

PART	WHAT TO USE	HOW TO CLEAN
Removable parts (shelves, crisper, etc.)	Sponge or cloth with mild detergent and warm water	<ul style="list-style-type: none"> • Hand wash, rinse and dry thoroughly.
Outside	Sponge, cloth or paper towel with mild detergent, warm water and an appliance wax (or good auto paste wax)	<ul style="list-style-type: none"> • Wash outside of cabinet. Do not use abrasive or harsh cleaners. • Rinse and dry thoroughly. • Wax painted metal surfaces at least twice a year. Apply wax with a clean, soft cloth. Waxing painted metal surfaces provides rust protection. Do not wax plastic parts.
Inside walls (freezer should be allowed to warm up so cloth won't stick)	Sponge, soft cloth or paper towel with baking soda or mild detergent and warm water	<ul style="list-style-type: none"> • Wash with mixture of warm water and <ul style="list-style-type: none"> – mild detergent, or – baking soda (26 g [2 tablespoons] to 0.95 L [1 quart] of water). • Rinse and dry thoroughly.
Door liners and gaskets	Sponge, soft cloth or paper towel with mild detergent and warm water	<ul style="list-style-type: none"> • Wash, rinse and dry thoroughly. <p>DO NOT USE cleaning waxes, concentrated detergents, bleaches or cleaners containing petroleum on plastic parts.</p>
Plastic parts (covers and panels)	Soft, clean sponge or soft, clean cloth with mild detergent and warm water	<ul style="list-style-type: none"> • Wash, rinse and dry thoroughly. <p>DO NOT USE paper towels, window sprays, scouring cleansers or flammable fluids. These can scratch or damage material. See "Important Safety Instructions" on page 3.</p>

PART	WHAT TO USE	HOW TO CLEAN
Defrost pan	Sponge or cloth with mild detergent and warm water	<ul style="list-style-type: none"> • Remove base grille. (See page 16.) • To remove defrost pan, lift pan over wire brace (remove tape; if any). • Wash, rinse and dry thoroughly. • Replace with notched corner to the rear. Push it in all the way. • Make sure defrost pan drain tube is pointing into pan. • Replace base grille.
Condenser coils	Vacuum cleaner with extended narrow attachment	<ul style="list-style-type: none"> • Remove base grille. • Vacuum coils when dusty or dirty. Coils may need to be cleaned as often as every other month. • Replace base grille.
Floor under refrigerator	Floor cleaners	<ul style="list-style-type: none"> • Roll refrigerator out only as far as the water supply line allows. • Clean floor. • Roll refrigerator back into place. • Check to see if the refrigerator is level.

Holiday and moving care

Long holidays

Remove all the food if you are going for a month or more. Turn off the water supply to the ice maker at least one day ahead. When the last load of ice drops, turn off the ice maker. Make sure all ice crescents are dispensed out of the mechanism.

Unplug the refrigerator. Clean, rinse it well and dry. Tape rubber or wood blocks to the tops of both doors to prop them open far enough for air to get in. This will keep odor and mold from building up.

⚠ WARNING

Personal Injury Hazard

Do not allow children to climb on, play near or climb inside the refrigerator when the doors are blocked open.

They may become injured or trapped.

To restart refrigerator, see "Using Your Refrigerator" on page 7.

Short holidays

No need to shut off the refrigerator if you will be away for less than four weeks. Use up perishables; freeze other items.

1. Turn off your ice maker by raising signal arm.
2. Shut off the water supply to the ice maker.
3. Empty the ice bin.

Moving

Shut off the ice maker water supply a day ahead of time. Disconnect the water line. After the last supply of ice drops, lift the signal arm to turn off the ice maker.

Remove all food. Pack frozen food in dry ice. Unplug the refrigerator and clean it thoroughly.

Take out all removable parts. Wrap all parts well and tape them together so they don't shift and rattle. Screw in the leveling legs; tape the doors shut; and tape the electric cord to the cabinet.

When you get to your new home, put everything back and refer to page 5. Also, remember to reconnect the water supply line.

Power interruptions

If electricity goes off, call the power company. Ask how long power will be off.

1. If service is to be interrupted 24 hours or less, **keep both doors closed**. This will help foods stay frozen.

2. If service is to be interrupted longer than 24 hours:

(a) Remove all frozen food and store in a frozen food locker.

OR

(b) Place 0.9 kg (2 lbs.) of dry ice in freezer for every cubic foot of freezer space. This will keep food frozen for 2 to 4 days. Wear gloves to protect your hands from dry ice burns.

OR

(c) If neither a food locker or dry ice is available, use or can perishable food at once.

3. A full freezer will stay cold longer than a partly filled one. A freezer full of meat will stay cold longer than a freezer full of baked goods. If food contains ice crystals, it may be safely refrozen, although the quality and flavor may be affected. If the condition of the food is poor or if you feel it is unsafe, dispose of it.

Food Storage Guide

In This Section

	Page		Page
Storing fresh food	20	Storing frozen food	21

There is a correct way to package and store refrigerated or frozen food. To keep food fresher, longer, take the time to study these recommended steps.

Storing fresh food

Food placed in the refrigerator should be wrapped or stored in air and moisture proof material. This prevents food odor and taste transfer throughout the refrigerator. For dated products, check code date to ensure freshness.

Leafy vegetables

Remove store wrapping and trim or tear off bruised and discolored areas. Wash in cold water and drain. Place in plastic bag or plastic container and store in crisper.

Vegetables with skins (carrots, peppers)

Store in crisper, plastic bags or plastic container.

Fruit

Wash, let dry and store in refrigerator in plastic bags or crisper. Do not wash or hull berries until they are ready to use. Sort and keep berries in their store container in a crisper, or store in a loosely closed paper bag on a refrigerator shelf.

Eggs

Store without washing in the original carton on interior shelf. Egg bin is provided on some models.

Milk

Wipe milk cartons. For best storage, place milk on interior shelf.

Butter or margarine

Keep opened butter in covered dish or closed compartment. When storing an extra supply, wrap in freezer packaging and freeze.

Cheese

Store in the original wrapping until you are ready to use it. Once opened, rewrap tightly in plastic wrap or aluminum foil.

Leftovers

Cover leftovers with plastic wrap or aluminum foil. Plastic containers with tight lids can also be used.

Meat

Most meat can be stored in original wrapping as long as it is air and moisture proof. Rewrap if necessary. See the following chart for storage times.

TYPE	APPROXIMATE TIME (DAYS) [†]
Chicken	1 to 2
Ground beef	1 to 2
Steaks and roasts	3 to 5
Cured meats	7 to 10
Bacon	5 to 7
Cold cuts	3 to 5
Variety meats	1 to 2

[†] If meat is to be stored longer than the times given, follow the directions for freezing.

NOTE: Fresh fish and shellfish should be used the same day as purchased.

Storing frozen food

The freezer section is designed for storage of commercially frozen food and for freezing food at home.

NOTE: For further information about preparing food for freezing or about food storage times, contact your local Cooperative Extension Service or check a freezer guide or reliable cookbook.

Packaging

The secret of successful freezing is in the packaging. The way you close and seal the package must not allow air or moisture in or out. Packaging done in any other way could cause food odor and taste transfer throughout the refrigerator and drying of frozen food.

Packaging recommended for use:

- Rigid plastic containers with tight-fitting lids
- Straight-sided canning/freezing jars
- Heavy-duty aluminum foil
- Plastic-coated paper
- Non-permeable plastic wraps (made from a saran film)

Follow package or container instructions for proper freezing methods.

Do not use:

- Bread wrappers
- Non-polyethylene plastic containers
- Containers without tight lids
- Waxed paper
- Waxed-coated freezer wrap
- Thin, semi-permeable wrap

The use of these wrappings could cause food odor, taste transfer and drying of frozen food.

Freezing

Do not expect your freezer to quick-freeze any large quantity of food. Put no more unfrozen food into the freezer than will freeze within 24 hours. (No more than 0.9 to 1.4 kg [2 to 3 pounds] of food per cubic foot of freezer space.) Leave enough space for air to circulate around packages. Be careful to leave enough room at the front so the door can close tightly.

Storage times will vary according to the quality of the food, the type of packaging or wrap used (air and moisture proof) and the storage temperature (which should be -17.8°C [0°F]).

If You Need Assistance Or Service

This section is designed to help you save the cost of a service call. Part 1 of this section outlines possible problems, their causes, and actions you can take to solve each problem. Parts 2 and 3 tell you what to do if you still need assistance or service. When calling an authorized Whirlpool® service company for help or calling for service, please provide a detailed description of the problem, your appliance's complete model and serial numbers and the purchase date. (See page 2.) This information will help us respond properly to your request.

1. Before calling for assistance ...

Performance problems often result from little things you can find and fix without tools of any kind. Please check the chart below for problems you can fix. It could save you the cost of a service call.

PROBLEM	POSSIBLE CAUSE	SOLUTION
Your refrigerator will not operate	The power supply cord is not plugged into a live circuit with proper voltage.	Firmly plug power cord into a live circuit with proper voltage. (See page 5.)
	A household fuse has blown or circuit breaker tripped.	Replace household fuse or reset circuit breaker.
	The Refrigerator Control is not set correctly.	Set Refrigerator Control to a numbered setting. (See page 7.)
Unfamiliar sounds or a rattling/jingling noise	There is something on top of or behind the refrigerator.	Remove item from on top of or behind the refrigerator.
	The sounds are normal.	New features on your new refrigerator make new sounds. (See "Understanding the sounds you may hear" on page 17.)
There is water in the defrost pan	This is normal in hot, muggy weather. The pan may even be half full.	Make sure the refrigerator is level so the pan does not overflow.
The lights do not work	A household fuse has blown or circuit breaker tripped.	Replace household fuse or reset circuit breaker.
	The power supply cord is not plugged into a live circuit with proper voltage.	Firmly plug power cord into a live circuit with proper voltage. (See page 5.)
	The bulb is burned out.	Replace bulb. (See page 16.)
The ice maker will not operate	The freezer has not had enough time to get cold.	Allow the freezer time to get cold—this could take overnight.
	The signal arm is in the OFF (up) position.	Push signal arm down to the ON position. (See page 13.)
	The water valve is turned off.	Turn the water valve on.
	Water is not getting to the ice maker.	Check the water line for clogs or leaks.
The motor seems to run too much	The condenser coils are dirty. It is hot outside or in the room.	Clean the coils (See page 19.) On hot days, or if the room is too warm, the motor naturally runs longer.
	The door has been opened frequently.	Open the door as few times as possible.
	A large amount of food has been put in at one time.	The motor will run longer in order to cool down the interior when food is added.

Remember:

Motor running time depends on different things: number of door openings, amount of food stored, temperature of the room, setting of controls, etc.

Your new refrigerator may be larger than your old one so it has more space to be cooled. It also has a regular freezer instead of a frozen food compartment. All this means better refrigeration and may require more running time than your old one.

2. If the problem is not due to one of the items listed in Step 1 ...

Contact the dealer from whom you purchased the unit or an authorized Whirlpool* service company.

3. If you need FSP* replacement parts ...

FSP is a protected trademark of Whirlpool Corporation for quality parts. Look for this symbol of quality whenever you need a replacement part for your Whirlpool appliance. FSP replacement parts will fit right and work right, because they are made to the same exacting specifications used to build every new Whirlpool appliance.

To locate FSP replacement parts in your area, contact the dealer from whom you purchased the unit or an authorized Whirlpool* service company.

WHIRLPOOL*

Refrigerator Warranty

LENGTH OF WARRANTY	WHIRLPOOL WILL PAY FOR
FULL ONE-YEAR WARRANTY From Date of Purchase	FSP* replacement parts and repair labor to correct defects in materials or workmanship. Service must be provided by an authorized Whirlpool* service company.
FULL FIVE-YEAR WARRANTY From Date of Purchase	FSP replacement parts and repair labor to correct defects in materials or workmanship in the sealed refrigeration system. These parts are: <ol style="list-style-type: none"> 1. Compressor 2. Evaporator 3. Condenser 4. Drier 5. Connecting tubing Service must be provided by an authorized Whirlpool* service company.
WHIRLPOOL WILL NOT PAY FOR	
<p>A. Service calls to:</p> <ol style="list-style-type: none"> 1. Correct the installation of the refrigerator. 2. Instruct you how to use the refrigerator. 3. Replace house fuses or correct house wiring or plumbing. 4. Replace light bulbs. <p>B. Repairs when refrigerator is used in other than normal, single-family household use.</p> <p>C. Pickup and delivery. This product is designed to be repaired in the home.</p> <p>D. Damage to refrigerator caused by accident, misuse, fire, flood, acts of God or use of products not approved by Whirlpool.</p> <p>E. Any food loss due to product failure.</p> <p>F. Repairs to parts or systems caused by unauthorized modifications made to the appliance.</p>	

8-92

WHIRLPOOL CORPORATION SHALL NOT BE LIABLE FOR INCIDENTAL OR CONSEQUENTIAL DAMAGES.

Outside the United States, a different warranty may apply. For details, please contact your authorized Whirlpool distributor or military exchange.